

igus<sup>®</sup>



iglide<sup>®</sup> PRT



## iglide® Bearings PRT - Technical Data

### Product Range

- Available in 3 Styles
- Inner diameters:  
Metric sizes from 20 - 300 mm

### Part Number Structure

Part Number Structure

#### PRT - 01 - 30 - ES

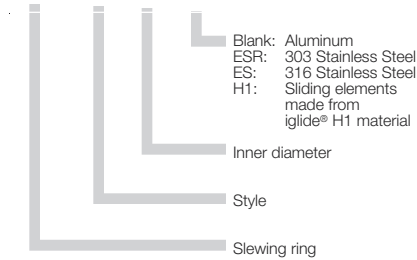

### Maximum Speed

Part No.	Max rpm
PRT-02-20	250
PRT-02-30	200
PRT-02-60	120
PRT-01-20	300
PRT-01-30	250
PRT-01-60	200
PRT-01-100	150
PRT-01-150	100
PRT-01-200	80
PRT-01-300	50

### Usage Guidelines



- When a ready-to-install solution is needed
- When a robust and corrosion resistant bearing unit with high load capacity is needed
- For high moments
- For use in dirty environments
- For maintenance-free applications without lubrication
- For slow to medium speeds



- For fast rotations
- When there is not enough driving torque at high loads
- When extreme precision is needed

iglide® PRT is a slewing ring bearing with the proven advantage of igus® plastic bearings. The iglide® J sliding elements are completely maintenance-free and lubrication-free. All the housing components are made of aluminum (except style 02, which has iglide® J4 head rings), and all the parallel surfaces of iglide® J sliding elements are hard anodized. All the fixing screws are made of stainless steel. The PRT slewing rings are available on request in stainless steel.



### Load

iglide® PRT slewing rings have varying load capacities depending on the type of load. All data can be used for both horizontal and lateral assembly. For cantilevered loads please see eccentric load chart on page 36.3 for required torque. Also feel free to contact our technical sales department for any application assistance.

See the chart on page 36.3 for load capabilities of the standard -01 version and page 36.5 for the load capabilities of the lightweight -02 version.

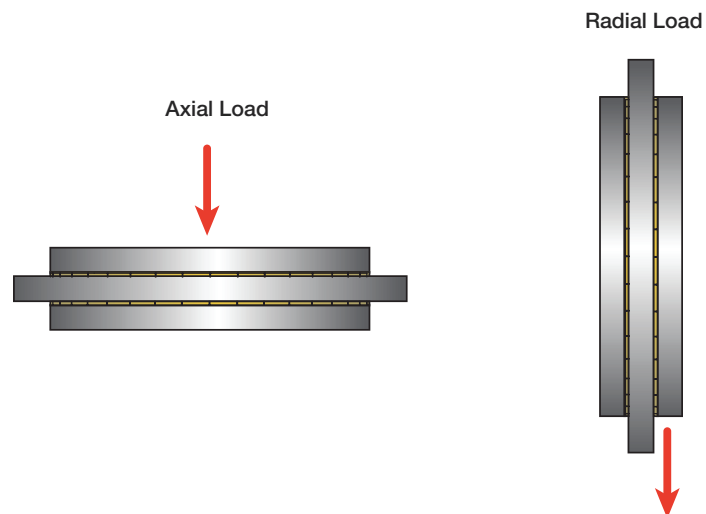



Dimensions

Part No.	Weight lbs	Axial Load		Radial Load		Max. rpm dry 1/rpm	Rigidity		Max. Permissible tilting moment lbs•ft
		static lbs	dynamic lbs	static lbs	dynamic lbs		axial N/μm	radial N/μm	
PRT-01-20	0.40	3370	900	517	135	300	80	10	73
PRT-01-30	0.88	6,070	1,573	1,124	337	250	100	50	147
PRT-01-60	2.43	11,240	3,372	2,248	674	200	300	65	590
PRT-01-100	2.87	12,364	3,596	3,596	1,124	150	400	65	1,106
PRT-01-150	4.85	17,984	5,620	5,620	1,798	100	450	65	1,475
PRT-01-200	7.05	22,480	6,744	7,868	2,248	80	500	65	2,802
PRT-01-300	16.75	33,721	20,232	10,116	6,069	50	500	65	3,687

iglide® PRT

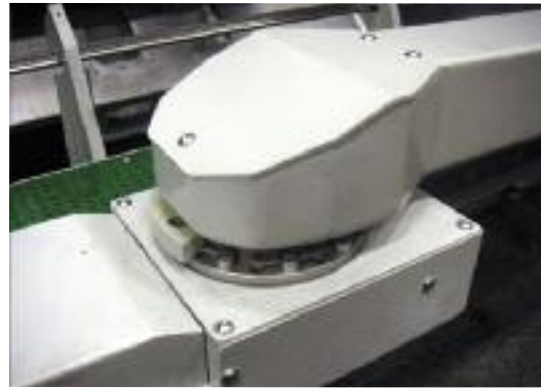
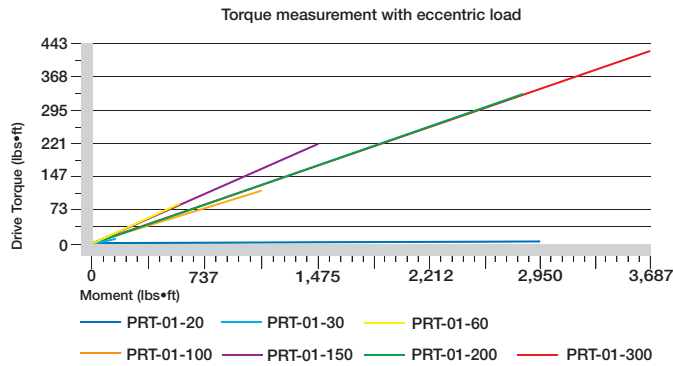

PRT in CNC machine

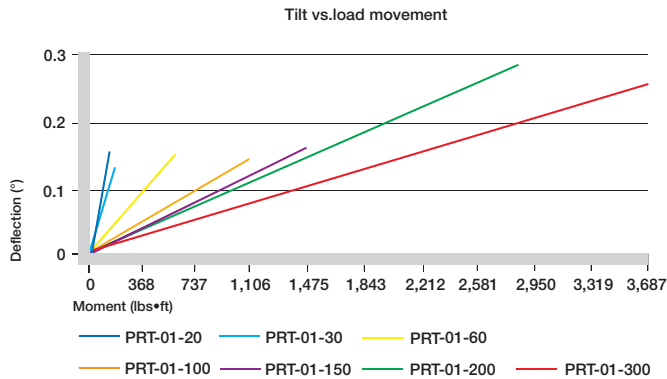

PRT in welding plant

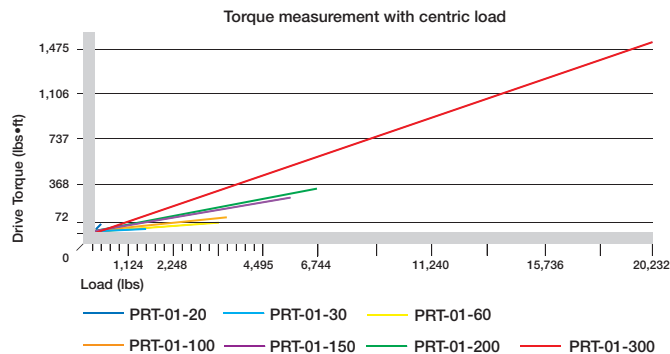

All load values assume the PRT is assembled with socket head screws (strength class 8.8) on the outside pitch circle diameter. For the assembly of the PRT the screws have to be inserted to a minimum thread depth of 2x the amount of the bores in the outer ring. All data can be used for both lateral and horizontal assembly.

- PRT-01-20: M4, min. 6 screws
- PRT-01-30: M4, min. 8 screws
- PRT-01-60: M5, min. 10 screws
- PRT-01-100: M5, min. 12 screws
- PRT-01-150: M5, min. 12 screws
- PRT-01-200: M6, min. 12 screws
- PRT-01-300: M8, min. 12 screws

PDF: [www.igus.com/iglide-pdfs](http://www.igus.com/iglide-pdfs)  
CAD: [www.igus.com/iglide-CAD](http://www.igus.com/iglide-CAD)  
RoHS info: [www.igus.com/RoHS](http://www.igus.com/RoHS)

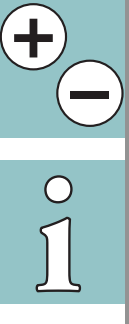



iglide® PRT

Telephone 1-800-521-2747  
 Fax 1-401-438-7270

Internet: <http://www.igus.com>  
 email: [sales@igus.com](mailto:sales@igus.com)  
 QuickSpec: <http://www.igus.com/iglide-quickspec>



PRT-01-300

### Advantages

- High rigidity
- Easy to install, iglide® J sliding pads
- High wear resistance
- Available in aluminum or stainless steel

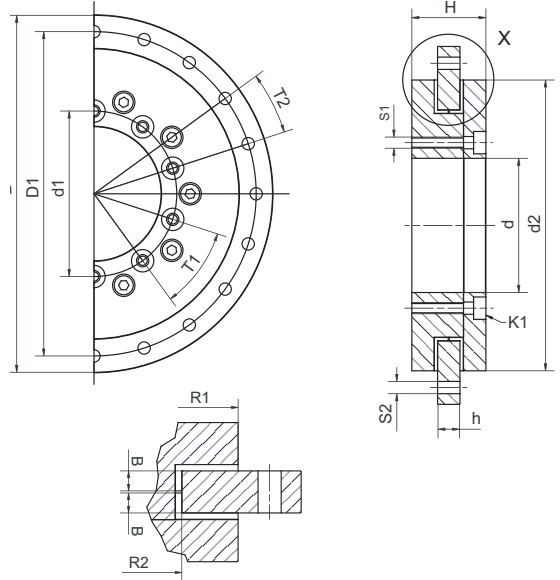
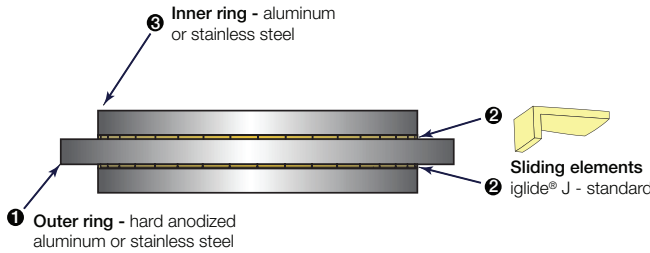

### Dimensions (mm)

Part No.	D*	D1	d1	d	d2	H	h	T1	T2	S1	S2	K1	R1	R2	B
					±0.2							for screw			
PRT-01-20	80	70	31	20	60	24	8	3 x 120°	6 x 60°	M4	4.5	DIN 7984 M4	30	20	3.5
PRT-01-30	100	91	42.5	30	82	29	10	8 x 45°	8 x 45°	M4	4.5	DIN 7984 M4	41	29	4.5
PRT-01-60	160	145	74	60	130	33	10	10 x 36°	20 x 18°	M5	5.5	DIN 912 M5	65	51.5	4.5
PRT-01-100	185	170	112	100	160	34	12	12 x 30°	16 x 22.5°	M5	5.5	DIN 912 M5	80	69	5.5
PRT-01-150	250	235	165	150	220	35	12	12 x 30°	16 x 22.5°	M5	5.5	DIN 912 M5	110	96.5	5.5
PRT-01-200	300	285	215	200	274	38	15	12 x 30°	16 x 22.5°	M6	6.6	DIN 912 M6	137	124	7.0
PRT-01-300	450	430	320	300	410	42	15	12 x 30°	16 x 22.5°	M8	9.0	DIN 7984 M8	205	186.6	7.0

To order the 316 stainless steel option please add the suffix 'ES' to the end of the part number. Example: PRT-01-60ES

To order the 303 stainless steel option please add the suffix 'ESR' to the end of the part number. Example: PRT-01-60ESR (standard stainless option. Other options are available, please call iglus® for more information. \*Tolerance according to DIN ISO 2768 mK

## iglide® PRT Slewing Ring Bearing, High Temperature, Style 01



### Advantages

- Suitable up to 356°F, high chemical resistance
- For all 7 standard dimensions of style 01
- Body in aluminum or stainless steel, sliding parts in iglide® H1

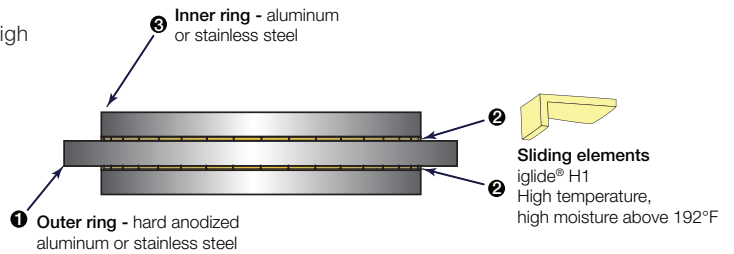

### Dimensions (mm)

Part No.	D*	D1	d1	d	d2	H	h	T1	T2	S1	S2	K1	R1	R2	B
					±0.2							for screw			
PRT-01-20-H1	80	70	31	20	60	24	8	3 x 120°	6 x 60°	M4	4.5	DIN 7984 M4	30	20	3.5
PRT-01-30-H1	100	91	42.5	30	82	29	10	8 x 45°	8 x 45°	M4	4.5	DIN 7984 M4	41	29	4.5
PRT-01-60-H1	160	145	74	60	130	33	10	10 x 36°	20 x 18°	M5	5.5	DIN 912 M5	65	51.5	4.5
PRT-01-100-H1	185	170	112	100	160	34	12	12 x 30°	16 x 22.5°	M5	5.5	DIN 912 M5	80	69	5.5
PRT-01-150-H1	250	235	165	150	220	35	12	12 x 30°	16 x 22.5°	M5	5.5	DIN 912 M5	110	96.5	5.5
PRT-01-200-H1	300	285	215	200	274	38	15	12 x 30°	16 x 22.5°	M6	6.6	DIN 912 M6	137	124	7.0
PRT-01-300-H1	450	430	320	300	410	42	15	12 x 30°	16 x 22.5°	M8	9.0	DIN 7984 M8	205	186.6	7.0

To order the H1 with 316 stainless steel option please add the suffix 'HES' to the end of the part number. Example: PRT-01-60HES

To order the H1 with 303 stainless steel option please add the suffix 'HESR' to the end of the part number. Example: PRT-01-60HESR (standard stainless option. \* Tolerance according to DIN ISO 2768 mK

# iglide® Bearings PRT - Slewing Ring Bearing, Style 02



### Advantages

- Lightweight
- Outer ring made from hard anodized Aluminum or stainless steel
- iglide® J4 inner rings – sliding against the outer ring without lubrication
- Low cost



Outer ring available in stainless steel as an option. Inner rings made from iglide® J4

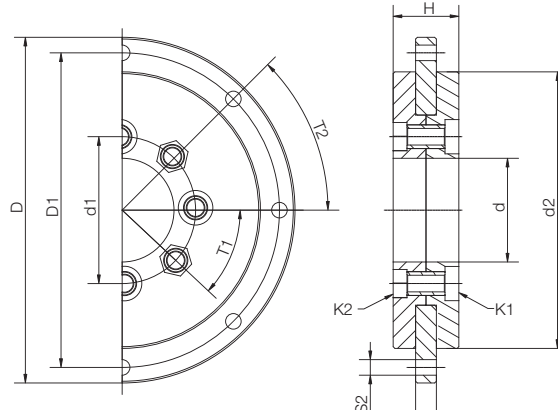
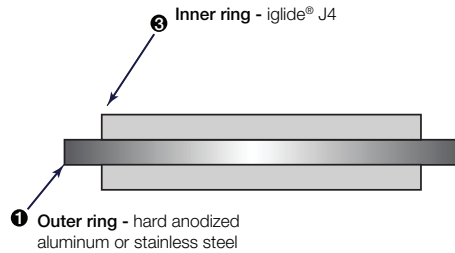

### Dimensions (mm)

Part No.	D	D1	d1	d	d2	H	h	T1	T2	S2	K1 For Screw	K2 For Screw
PRT-02-20-AL	80	70	31	20	60	16	5	6 x 60°	6 x 60°	4.5	DIN 6912-172 M5	DIN 439-A2 M5
PRT-02-30-AL	100	91	42.5	30	80	19	6	8 x 45°	8 x 45°	4.5	DIN 7984 M5	DIN 439 M5A2
PRT-02-60-AL	160	145	86.5	60	130	30	10	6 x 60°	20 x 18°	5.5	DIN 931 M5x25	DIN 934 M5

Please add "ES" to the Part No. for stainless steel (316 SS)

Properties	Unit	PRT-02-20-AL	PRT-02-30-AL	PRT-02-60-AL
Weight	lbs	0.22	0.44	1.54
Max. axial load, static	lbf	2,923	5,620	10,116
Max. axial load, dynamic	lbf	899	1,574	2,698
Max. radial load, static	lbf	450	562	2,248
Max. radial load, dynamic	lbf	112	157	630
Max. rotational speed dry running	1/min	250	200	120
Max. permissible tilting moment	lbs•ft	45	74	148

## PRT - Slewing Ring Bearing, FDA Compliant, Style 02



### Advantages

- For use in the food technology with inner rings made from FDA-compliant material iglide® A180
- The stainless steel outer ring and the material iglide® A180 are suitable for the direct contact with food, pharmaceuticals and humidity.
- Low profile and low weight
- Easy to install
- Totally lubrication-free

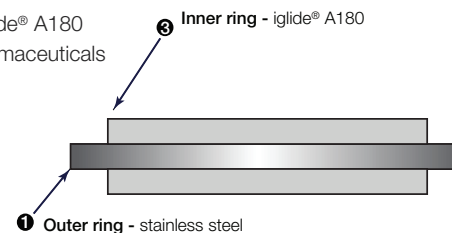

### Dimensions (mm)

Part No.	D	D1	d1	d	d2	H	h	T1	T2	S2	K1 for screw	K2 for screw
PRT-02-30-ES-A180	100	91	42.5	30	80	19	6	8x45	8x45	4.5	DIN 7984 M5	DIN 439-A2 M5

\*Part available by special request

iglide® PRT

PDF: [www.igus.com/iglide-pdfs](http://www.igus.com/iglide-pdfs)  
CAD: [www.igus.com/iglide-CAD](http://www.igus.com/iglide-CAD)  
RoHS info: [www.igus.com/RoHS](http://www.igus.com/RoHS)





iglide® PRT

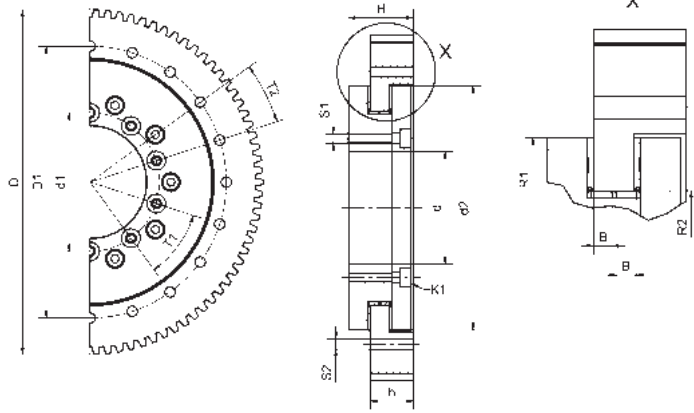

Geared PRT's are now the standard for driving a PRT by belt, rack, or pinion gear. There are 4 different gear options offered in hard anodized aluminum.

- Maintenance- and lubrication-free
- Ready to fit
- Robust and corrosion-resistant

Telephone 1-800-521-2747  
1-401-438-7270

Fax

### Dimensions (mm)

Part No.	D1 (mm)	d1 (mm)	d (mm)	d2 (mm)	h (mm)	T1 (°)	T2 (°)	S1	S2	K1	R1 (mm)	R2 (mm)	B (mm)	H (mm)
PRT-30- <input type="text"/>	91	42.5	30	82	21	8 x 45	8 x 45	M4	4.5	DIN 912 M4	41	29.0	4.5	(30.4)
PRT-60- <input type="text"/>	145	74.0	60	130	23	10 x 36	20 x 18	M5	5.5	DIN 912 M5	65	51.5	4.5	(34.5)
PRT-100- <input type="text"/>	170	112.0	100	160	25	12 x 30	16 x 22.5	M5	5.5	DIN 912 M5	80	69.0	5.5	(36.0)
PRT-150- <input type="text"/>	235	165.0	150	220	25	12 x 30	16 x 22.5	M5	5.5	DIN 912 M5	110	96.5	5.5	(37.5)
PRT-200- <input type="text"/>	285	215.0	200	274	30	12 x 30	16 x 22.5	M6	7.0	DIN 912 M6	137	124.0	7.0	(41.5)
PRT-300- <input type="text"/>	430	320.0	300	410	30	12 x 30	16 x 22.5	M8	9.0	DIN 912 M8	205	186.5	8.5	(46.5)

Fill in the box with the required toothed belt profile from below.  
Example: PRT-30-ST

### Spur gearing DIN 3967 (ST)

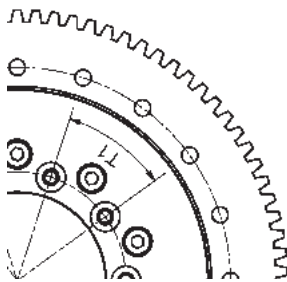

Part No.	m modulus	z # of Teeth	D (mm)
...-ST	2	54	(112)
...-ST	2	90	(184)
...-ST	2	96	(196)
...-ST	2	126	(256)
...-ST	2	152	(308)
...-ST	3	152	(462)

### Toothed belt profile (AT10)

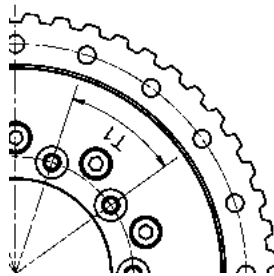

Part No.	z # of Teeth	D (mm)
...-AT10	34	(106.4)
...-AT10	52	(163.8)
...-AT10	60	(189.2)
...-AT10	80	(252.9)
...-AT10	96	(303.9)
...-AT10	144	(456.7)

### Toothed belt profile (T10)

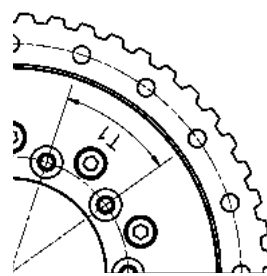

Part No.	z # of Teeth	D (mm)
...-T10	34	(106.4)
...-T10	52	(163.8)
...-T10	60	(189.2)
...-T10	80	(252.9)
...-T10	96	(303.9)
...-T10	144	(456.7)

### Toothed belt profile (HTD8M)

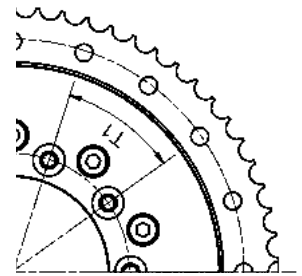

Part No.	z # of Teeth	D (mm)
...-HTD8M	42	(105.6)
...-HTD8M	66	(166.7)
...-HTD8M	72	(189.2)
...-HTD8M	100	(253.3)
...-HTD8M	120	(304.3)
...-HTD8M	180	(457.1)

Internet: <http://www.igus.com>  
email: [sales@igus.com](mailto:sales@igus.com)  
QuickSpec: <http://www.igus.com/iglide-quickspec>

# iglide® Bearings

## PRT - Slewing Ring Bearing

### Style 01 with Squared Flange



The smallest PRT slewing ring bearing in size 20 is also available with space-saving square flange for direct mounting on flat surfaces.

- No intake hole necessary
- No separate spacer required
- Fixed only with 4 screws

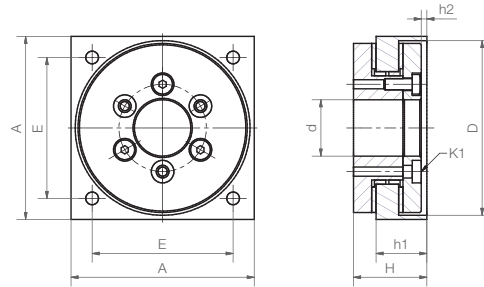

#### Dimensions (mm)

Part No.	d	D	A	E	H	h1 (°)	h2 (°)
PRT-01-20-SQ	20	62	65	50	26	18	2

## PRT - Slewing Ring Bearing, With Head Ring for Clamping



PRT-01-30 with head ring including clamping function for 30h7 toleranced shafts or other structures to be clamped.

- For easy handling structures
- Quick and easy installation
- Maximum tightening torque

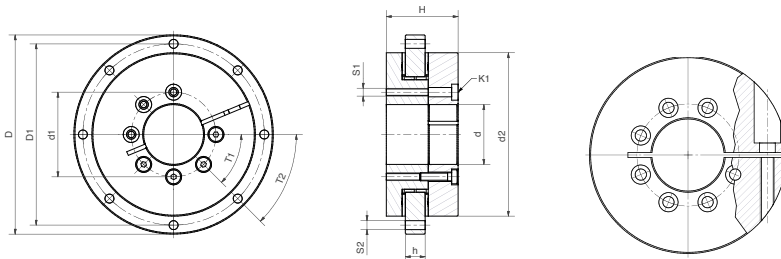

#### Dimensions (mm)

Part No.	D	D1	d1	d	d2	H	h	T1	T2	S1	S2	K1 for screw
PRT-01-30-C	100	91	42.5	30	80	19	6	8x45	8x45	M4	4.5	DIN 7984 M5

iglide® PRT

PDF: [www.igus.com/iglide-pdfs](http://www.igus.com/iglide-pdfs)  
 CAD: [www.igus.com/iglide-CAD](http://www.igus.com/iglide-CAD)  
 RoHS info: [www.igus.com/RoHS](http://www.igus.com/RoHS)





iglide® PRT

Telephone 1-800-521-2747  
1-401-438-7270  
Fax

Internet: <http://www.igus.com>  
email: [sales@igus.com](mailto:sales@igus.com)  
QuickSpec: <http://www.igus.com/iglide-quickspec>

### Drive plate



- For quick and easy drive coupling

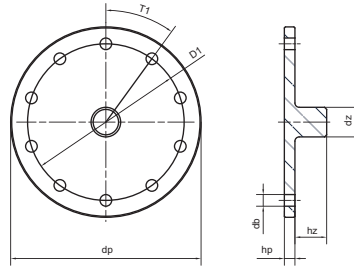

Picture shows PRT with fitted drive plate

Part No.	dp (mm)	hp (mm)	dz (mm)	hz (mm)	D1 (mm)	T1 (°)	db (mm)
PRT-AZ-30	55	5	10	15	42.5	8 x 45	4.5
PRT-AZ-60	90	5	14	15	74	10 x 36	5.5
PRT-AZ-100ES	125	8	20	20	112	12 x 30	5.5
PRT-AZ-150ES	180	10	20	20	165	12 x 30	4.5
PRT-AZ-200ES	230	10	20	20	215	12 x 30	7

Drive plates for the -100, -150 and the -200 are made from 303SS to meet their load capacity

### Mounting rings



- Easier, more flexible mounting
- No bore in the mounting face necessary

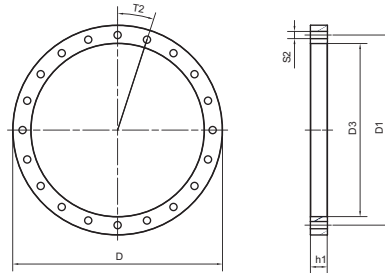

Picture shows PRT with fitted distance ring

Part No.	D (mm)	D1 (mm)	T2 (°)	S2 (mm)	D3 (mm)	h1 (mm)
PRT-01-30-DR	100	91	8 x 45	4.5	84	11
PRT-01-60-DR	160	145	20 x 18	5.5	132	13
PRT-01-100-DR	185	170	16 x 22.5	5.5	162	13
PRT-01-150-DR	250	235	16 x 22.5	5.5	222	13
PRT-01-200-DR	300	285	16 x 22.5	7.0	276	13
PRT-01-300-DR	450	430	16 x 22.5	9.0	412	15

### Plastic Mounting rings



- Lightweight
- No bore in the mounting face necessary

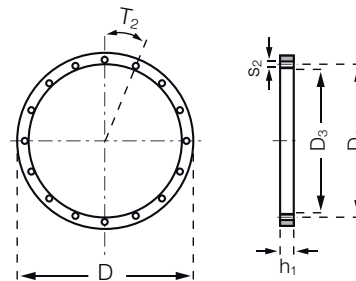

Part No.	D (mm)	D1 (mm)	T2 (°)	S2 (mm)	D3 (mm)	h1 (mm)
PRT-01-30-DRP	100	91	8 x 45	4.5	84	11
PRT-01-60-DRP	160	145	20 x 18	5.5	132	13
PRT-01-100-DRP	185	170	16 x 22.5	5.5	162	13





Hand clamp

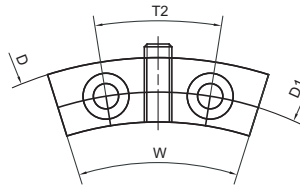
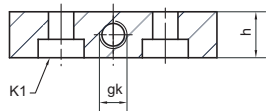

Picture shows PRT with fitted manual clamp

- With .75 lbs · ft screw torque a holding torque up to 7lbs · ft is possible
- Easy to screw onto outer ring

Part No.	D (mm)	D1 (mm)	T2 (°)	K1	h (mm)	gk	W (°)
PRT-HK-30	100	91	8 x 45	4.5	8	M5	60
PRT-HK-60	160	145	20 x 18	DIN 7984 M5	10	M6	35
PRT-HK-100*	205	185	16 x 22.5	DIN 7984 M5	12	M6	40
PRT-HK-200*	320	300	16 x 22.5	DIN 7984 M6	15	M6	40

\* Required with large outer rings

PRT with Large outer ring

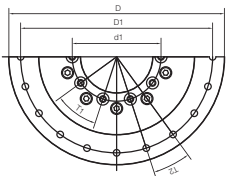

Part No.	D (mm)	D1 (mm)	d1 (mm)	T1 (°)	T2 (°)
PRT-01-100-G	205	185	112	12 x 30	16 x 22.5
PRT-01-200-G	320	300	215	12 x 30	16 x 22.5

iglide® PRT

PDF: [www.igus.com/iglide-pdfs](http://www.igus.com/iglide-pdfs)  
CAD: [www.igus.com/iglide-CAD](http://www.igus.com/iglide-CAD)  
RoHS info: [www.igus.com/RoHS](http://www.igus.com/RoHS)

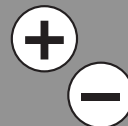



# iglide® Bearings PRT - Notes

iglide® PRT

Telephone 1-800-521-2747  
Fax 1-401-438-7270

Internet: <http://www.igus.com>  
email: [sales@igus.com](mailto:sales@igus.com)  
QuickSpec: <http://www.igus.com/iglide-quickspec>